



INSTALLATION AND SERVICING INSTRUCTIONS

6.0/6.4L FORD POWERSTROKE BYPASS SYSTEM

KIT FKPWR60CUSTOM

IMPORTANT NOTICE

Please Note – Before Installation

Follow the precautions below for optimal product performance and to reduce the risk of property damage, personal injury, and/or death.

Read All Instructions Before Proceeding

If you are uncomfortable with the instructions or have questions, do not attempt installation. Consult a mechanic or contact our customer service department at 800-341-6516 with any additional questions.

Improper installation of this product may result in damage to the vehicle on which it is installed. For questions regarding installation, contact Frantz customer service at 1-800-341-6516.

Install On Cool Engine

Never work in the engine compartment with the engine running. It is advised that you perform a full oil change with installation of this system.

A. BEFORE YOU BEGIN

1. Confirm all items on the Parts List are included in the system.
2. Ensure you have the required tools for the job.

RECOMMENDED TOOL LIST

- 9/16" wrench
- 1/2" wrench
- 3/8" wrench
- crescent wrench

PARTS LIST

6.0/6.4L Ford Powerstroke Frantz Filter Kit (FKPWR60CUSTOM)

Item	Description	Qty.	Part No.
1.	5/16 SS Nut	2	FNUT516
2.	5/16 x 3/4 SS Bolt	2	FBOLT
3.	5/16 SS Lock Washer	2	FLW516
4.	Base Gasket	1	KBGA
5.	Black Knob	1	KBLK
6.	V-Band Clamp	1	KVCLAMP
7.	Mounting Bracket	1	KMOU
8.	Cellulose Filter Media	1	FFMD-SP
9.	Polished Canister w/Decal	1	KCANP
10.	Pull Ring	1	KPUL
11.	Filter Base	1	KBAS
12.	Custom Braided Hose - 24"	1	FHOS24
13.	Custom Braided Hose - 36"	1	FHOS36
14.	90 Degree Brass Elbow	2	FELB90

Parts List (cont.)

Item	Description	Qty.	Part No.
15.	Spare Gasket	2	KBGA
16.	Thread Seal Package	2	FTHR
17.	6.0/6.4 Oil Filter Cap	1	FPFC-PWR
18.	Quick Disconnect - Female	2	FPDC-F
19.	Quick Disconnect - Male	2	FPDC-M
20.	45 Degree Brass Elbow	2	FELB45
21.	6.0/6.4 Oil Fill Cap w/Gasket	1	FPFC-PWR
22.	Straight 4 AN to 1/8" NPT	4	4AN/1/8"NPT
23.	Magnets	3	FMAG
24.	Nuts	3	FMAGNUT
25.	Washers	3	FMAGWASHER

Note: Be sure to use thread sealer at all connections. This is most important for connections with dissimilar metals (i.e. brass to aluminum).

B. INSTALLATION INSTRUCTIONS

(some parts for kit may be preinstalled)

MAKE SURE YOU USE THREAD SEAL (FTHR) ON THE THREADS.

1. Your kit comes with (3) magnets (FMAG), Nuts (FMAGNUT) and Washers (FMAGWASHER) that attach to the mounting bracket (KMOU). The filter base (KBAS) will attach to the mounting bracket with the (2) Lock Washers (FLW516), (2) Bolts (FBOLT) and (2) Nuts (FNUT516) found in your hardware bag.
2. Install the 90° fitting on the 36-inch braided hose (FHOS36) to the 4AN fitting that is pre-installed on the center port of the filter base (KBAS). This is the pressure side of the filter. (The straight end will have the female quick disconnect preinstalled.) Install the 90° fitting on the 24-inch braided hose (FHOS24) to the 4AN fitting that is pre-installed to the out-port on filter base (KBAS). This will be the oil return line. (The straight end will have the female quick disconnect preinstalled.) Tighten braided hose fittings using a 9/16" wrench.
3. Hand tighten the v-band clamp (KVCLAMP) on filter canister base using the Black Knob (KBLK) on the clamp. Make sure Black knob is accessible when mounting filter base to mounting bracket.
4. Mount the base via magnets to the inside wall of the engine bay (passenger side, back corner).
5. Thread male quick disconnect (FPDC-M) into the 45 degree brass elbow (FELB45) and tighten.
6. Replace factory oil fill cap with Frantz filter oil fill cap (FPDC-PWR).
7. Thread 45 degree brass elbow (with male quick disconnect already installed) into the Frantz filter oil fill cap (FPDC-PWR).

8. Connect the 24-inch return line (out port on filter base) via the quick disconnect to oil fill cap (FPDC-PWR) (push together, will snap when locked).
9. Remove factory oil filter cap and old oil filter.
10. Install the factory filter O-ring (use new O-ring if new filter came with one) onto the Frantz oil-filter cap (FPFTC-PWR) and then insert the new oil filter into the Frantz cap, install and tighten with crescent wrench (must use factory length filter).
11. Thread male quick disconnect (FPDC-M) into the 90 degree brass elbow (FELB90) and tighten.
12. Install 90 degree brass elbow (FELB90) (with male quick disconnect already installed) into oil filter cap (FPFTC-PWR).
13. Connect the 36-inch oil supply line to the oil filter cap (FPFTC-PWR) via the quick disconnect (push together, will stop when locked).
14. Check and tighten all fittings as needed.(verify placement of hoses are not rubbing on critical parts and adjust as necessary.)
15. Installation is now complete please follow start up procedures **(Section C)**.

C. START UP PROCEDURES

1. Check that all fittings and hoses are securely attached, and that the hoses are routed properly.
2. Check engine oil level. Fill to full mark on engine dipstick.
3. With the equipment secured start the engine and immediately check oil pressure. NOTE: Pressure may initially take a moment or two to rise. Let your engine run for a minimum of five minutes after installation. This allows your new Frantz Filter to begin absorbing oil in the media and fill the hoses.

Caution: carefully check for leaks at fittings, hoses and mount. If leaks are observed, **STOP ENGINE IMMEDIATELY**, repair leaks and continue.

4. After engine has been ran for a minimum of five minutes, shut off and re-check engine oil level. Fill as necessary.
5. Record vehicle mileage/operating hours and date of installation.

D. PERIODIC MAINTENANCE

1. Inspect the fittings and hoses. Check for leaks, hose deterioration and cuts. Repair and/or replace as necessary. **(At minimum at every oil change or every 3000 miles whichever occurs first.)**
2. Filter media should be changed when engine oil is up to operating temperature and the filter housing is not warm. **(This indicates oil is no longer flowing through the filter.)**

E. CHANGING THE FILTER ELEMENT

Caution: Engine should be cold when changing the filter element.

To change the bypass filter element:

1. Ensure the engine is off and use caution as the engine, oil and filter may be hot and can result in personal injury. **(Let engine cool down, or start with cold engine.)**

2. Loosen the black knob on the clamp and remove the clamp from the unit.
3. Pull filter housing off the filter base.
4. Grab pull ring to remove old filter from the canister, dispose of properly.
5. Clean out the Canister with a lint free rag and inspect filter base gasket, replace if any cuts or imperfections are found. Make sure gasket is sitting correctly in the receiver groove and coat with clean motor oil.
6. Install the new filter media with pull ring in the filter. Install canister back on filter base.
7. Install clamp on base. Tighten Clamp using black knob.
8. Check oil level and refill as needed.
9. Start the engine and check for leaks. (Run engine a minimum of 5 minutes.)
10. Stop engine.
11. Check oil level and refill as needed.
12. Record date of installation and miles/hours of the unit.

THE FRANTZ WARRANTY AND GUARANTEE

The Frantz Warranty

Frantz will replace any part or component that proves defective within 90 days. It will be replaced free of charge (no cost for labor) within that period.

NOTE: If an oil line fails, or an oil leak develops in the Frantz (either through failure of a part, sabotage, incorrect installation, or faulty servicing of the unit), and the engine loses its oil supply, Frantz disclaims any responsibility for damage to the engine should it be operated without proper lubrication.

Every vehicle has either a pressure gauge or warning light to indicate that oil pressure is not sufficient to lubricate the engine. When this occurs, it is the responsibility of the driver to stop the vehicle, investigate the problem, and take whatever remedial action is necessary.







The Frantz Guarantee

Frantz unconditionally states that if the Frantz has been installed and serviced in accordance with the manufacturer's instructions, the filter will keep the oil in your vehicle analytically clean. If it fails to do so, the purchase price of the unit will be refunded by the manufacturer, provided the filter, all parts and the original sales receipt are returned to Frantz. (Customer responsible for shipping cost back to manufacturer.)

6.0L/6.4L Ford Powerstroke Bypass System Kit FKPWR60CUSTOM

PARTS IDENTIFICATION







Pages 3 - 5

NAME	SKU	QTY	VISUAL
5/16 SS Nut	FNUT516	2	
5/16 x 3/4 Ss Bolt	FBOLT	2	
5/16 SS Lock Washer	FLW516	2	
Base Gasket	KBGA	1	
Black Knob	KBLK	1	
V-Band Clamp	KVCLAMP	1	
Mounting Bracket	KMOU	1	
Cellulose Filter Media	FFMD-SP	1	

6.0L/6.4L Ford Powerstroke Bypass System Kit FKPWR60CUSTOM

PARTS IDENTIFICATION

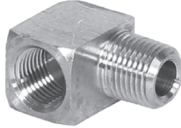







Pages 3 - 5

NAME	SKU	QTY	VISUAL
Polished Canister w/Decal	KCANP	1	
Pull Ring	KPUL	1	
Filter Base	KBAS	1	
Custom Braided Hose - 24"	FHOS24	1	
Custom Braided Hose - 36"	FHOS36	1	
90° Brass Elbow	FELB90	2	
Spare Gasket	KBGA	2	
Thread Seal Package	FTHR	2	

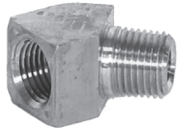
6.0L/6.4L Ford Powerstroke Bypass System Kit FKPWR60CUSTOM

PARTS IDENTIFICATION

Pages 3 - 5

NAME	SKU	QTY	VISUAL
6.0L/6.4L Oil Filter Cap	FPFTC-PWR	1	
Quick Disconnect	FPDC-F	2	
Quick Disconnect	FPDC-M	2	
45° Brass Elbow	FELB45	2	
6.0L/6.4L Oil Fill Cap w/Gasket	FPFC-PWR	1	
Straight 4 AN to 1/8" NPT	4AN/18"NPT	4	
Magnets	FMAG	3	
Nuts	FMAGNUT	3	
Washers	FMAGWASHER	3	

Engine Fittings and Adaptors

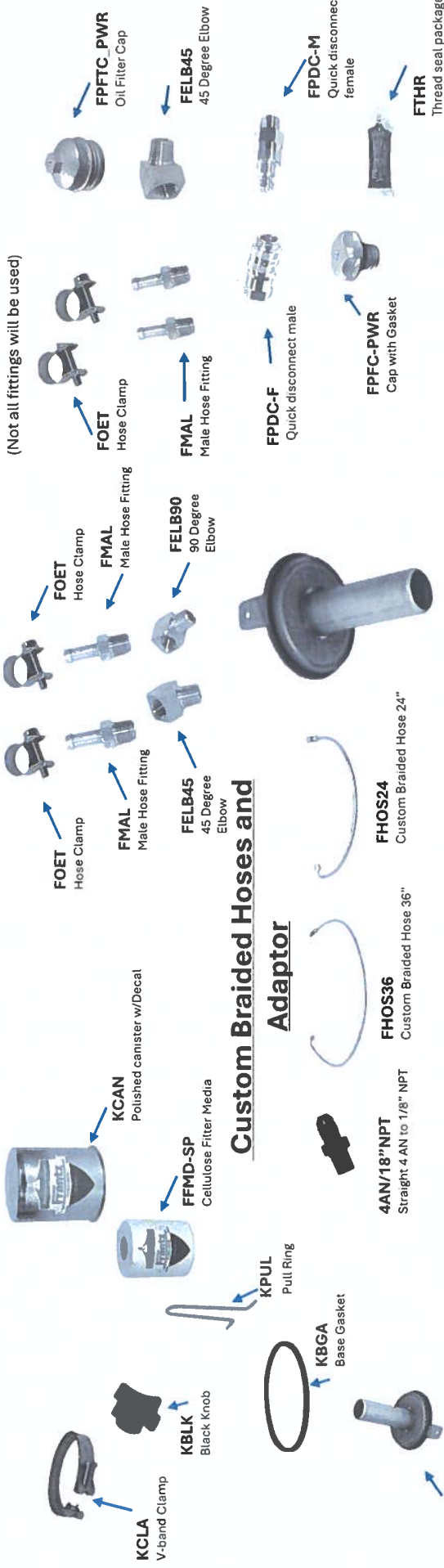

Filter Base Adaptors

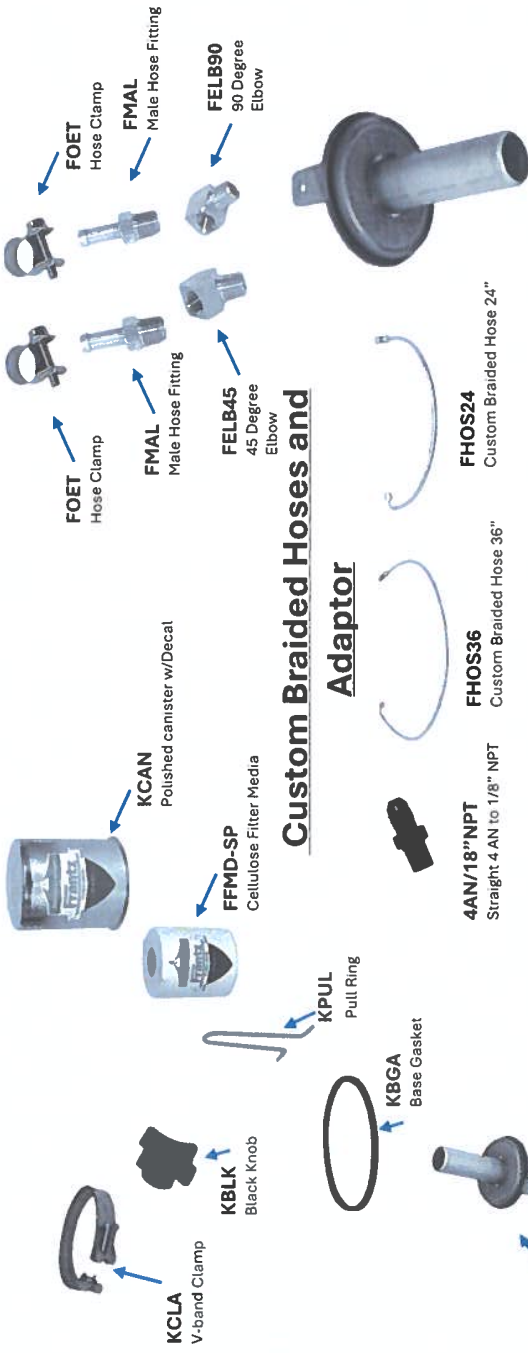

Engine Fittings and Adaptors

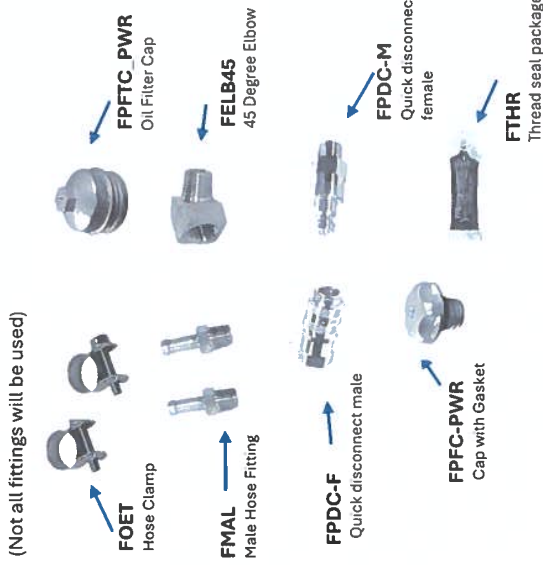

Custom Braided Hoses and Adaptor



Mounting Bracket and Hardware

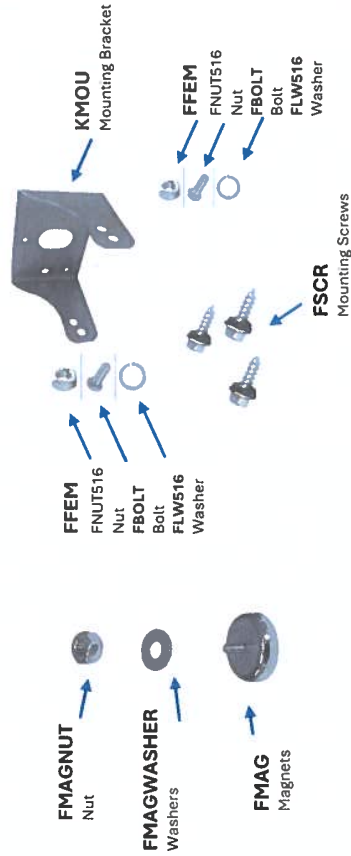

Spare Base Gaskets

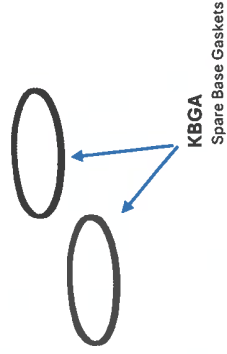

FKPWR60CUSTOM
6.0L/6.4 Ford Power
Stroke with Custom
Hoses, Magnet Mount Kit